



BR0300, BR0400, BR0600, BR0750 & BR0900 (White finish)

General description

- White painted steel straight grab bars with Polypropylene snap flanges, suitable for people with reduced mobility, elderly people or the handicapped, especially designed to make their life a little bit easier.
- Can be installed in horizontal, vertical or slanting position.
- Models suitable for both, home and public use.
- 32 mm diameter bar for easier gripping.
- Provide confidence and stability.
- Concealed fixings thanks to their Polypropylene snap flanges.
- Optionally, they have a kit to avoid electrical conductivity (code KA0010).
- Supplied with stainless steel screws for concrete walls.

Components and materials

- **TUBING:** made of 32 mm diameter tube, seamless construction. The bending process guarantees the uniformity of the diameter along the bends.
- **CONCEALED MOUNTING FLANGE:** two units made of steel, 3 mm thick. Incorporates two Ø 6.5 mm screws holes for wall mounting.
- **SNAP FLANGE COVER:** two units made of Polypropylene, 1.5 mm thick and Ø 85 mm. Each cover snaps over mounting flange to conceal mounting screws.

Dimensions

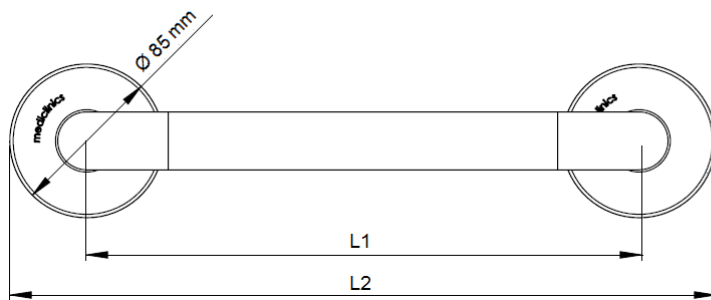

Grab bar code	L1 (mm)	L2 (mm)
BR0300	305	390
BR0400	455	540
BR0600	610	695
BR0750	760	845
BR0900	915	1.000

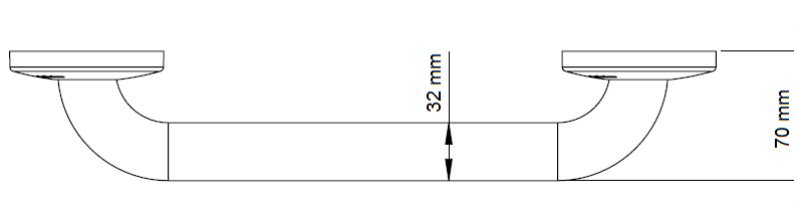

Technical specifications

Dimensions	See version table
Bar tube	Ø 32mm
Mounting flange	Ø 71,5 mm
Mounting flange thickness	3 mm
Snap flange cover	Ø 85 mm
Snap flange cover thickness	1,5 mm

MOUNTING TEMPLATE

Fix the grab bar to the wall through the 3 holes of the mounting flanges to the wall, using the screws provided and taking into account the distances of the points indicated by an "S" in the following figure:

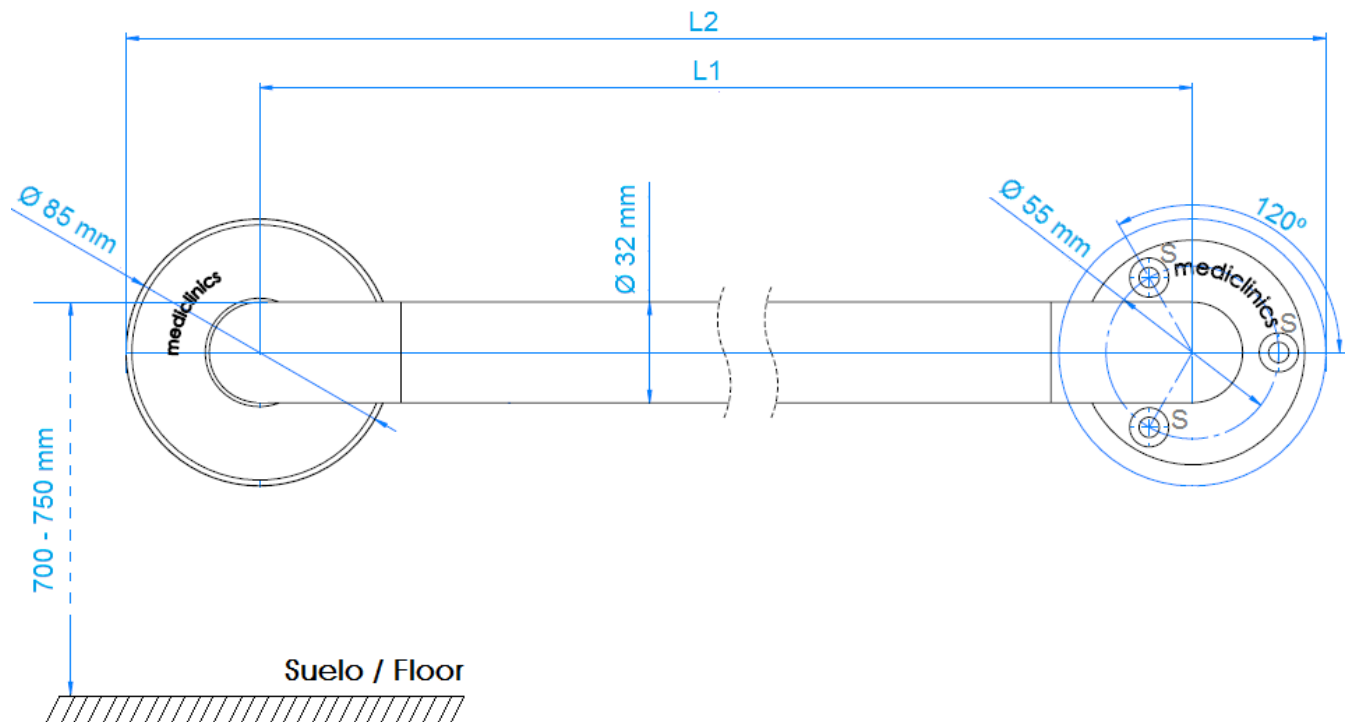

It is not recommended to install the Mediepoxy line bars in places where the bars will be in direct contact with water, in damp and/or chlorinated environments.

Mediclinics is not responsible for corrosion that may appear on the bars caused by abrasion on the anchorage points because of an improper installation.

Mediclinics, S.A., reserves the right to make changes and/or modifications to the products and their specifications without prior notice
 Review 01-19 © mediclinics S.A.

